

VEDERE DESFĂȘURATĂ KL 130.11.135

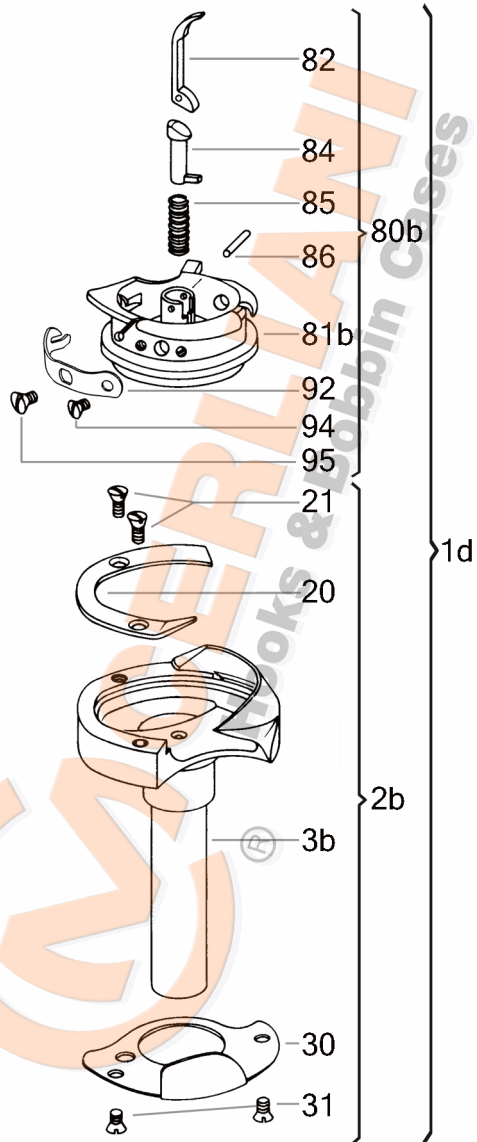

No	CERLIANI ARTICOL	DESCRIERE
1d	130.11.135	HOOK COMPLETE
2b	130.11.091	HOOK WITHOUT BASKET
20	130.11.019	HOOK GIB
21	130.11.004	HOOK GIB FASTENING SCREW
30	130.11.097	NEEDLE GUARD
31	130.11.049	NEEDLE GUARD FASTENING SCREW
60b	130.05.101	LUBRICATION FELT IN OIL CHANN.
60b	130.11.096	LUBRICATION FELT IN OIL CHANN.
70	130.05.104	LUBRIFICATION PLUG PIN
80b	130.11.136	COMPLETE BASKET
81b	130.11.137	BASKET BODY
82	130.11.100	LEVER
84	130.11.011	BOBBIN EJECTOR
85	130.11.014	SPIRAL SPRING OF LEVER
86	130.08.012	LEVER'S PIN
92	130.11.108	TENSION SPRING
94	130.11.020	TENSION SPRING FAST. SCREW
95	130.11.037	TENSION SPRING ADJ. SCREW
152	130.11.235	SCREW

ATENȚIE!!! Reprezentarea grafică arată doar tipologia componentelor articolului și poate să nu corespundă 100% realității.