

VEDERE DESFĂȘURATĂ KK 130.08.556

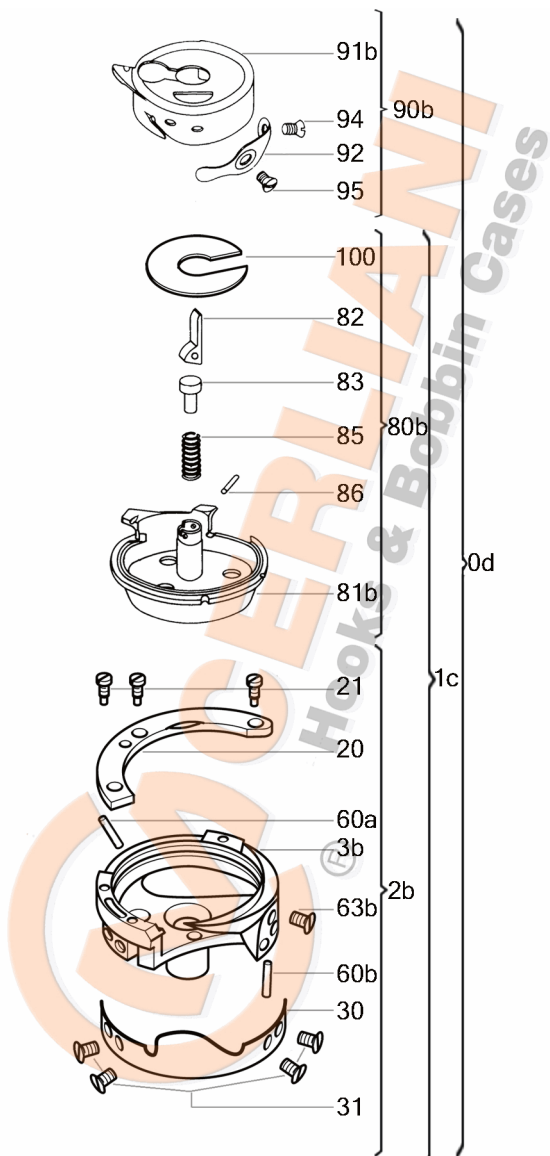

No	CERLIANI ARTICOL	DESCRIERE
0d	130.08.556	HOOK WITH CAP
1c	130.08.557	HOOK WITHOUT CAP
2b	130.08.550	HOOK WITHOUT BASKET
20	130.08.004	HOOK GIB
21	130.08.005	HOOK GIB FASTENING SCREW
30	130.08.552	NEEDLE GUARD
31	130.08.355	NEEDLE GUARD FASTENING SCREW
60a	130.08.024	LUBRICATION FELT (UNDER GIB)
60b	130.04.028	LUBRICATION FELT IN OIL CHANN.
70	130.05.104	LUBRIFICATION PLUG PIN
70	130.08.290	LUBRIFICATION PLUG PIN
80b	130.08.493	COMPLETE BASKET
82	130.08.010	LEVER
83	130.08.011	PISTON
86	130.08.012	LEVER'S PIN
90b	130.08.495	CAP
92	130.08.016	TENSION SPRING
94	130.06.104	TENSION SPRING FAST. SCREW
95	130.08.018	TENSION SPRING ADJ. SCREW
98	130.08.013	SPIRAL SPRING OF LATCH
100	130.08.469	BOBBIN BRAKE SPRING

ATENȚIE!!! Reprezentarea grafică arată doar tipologia componentelor articolului și poate să nu corespundă 100% realității.