

VEDERE DESFĂȘURATĂ KK 130.08.370

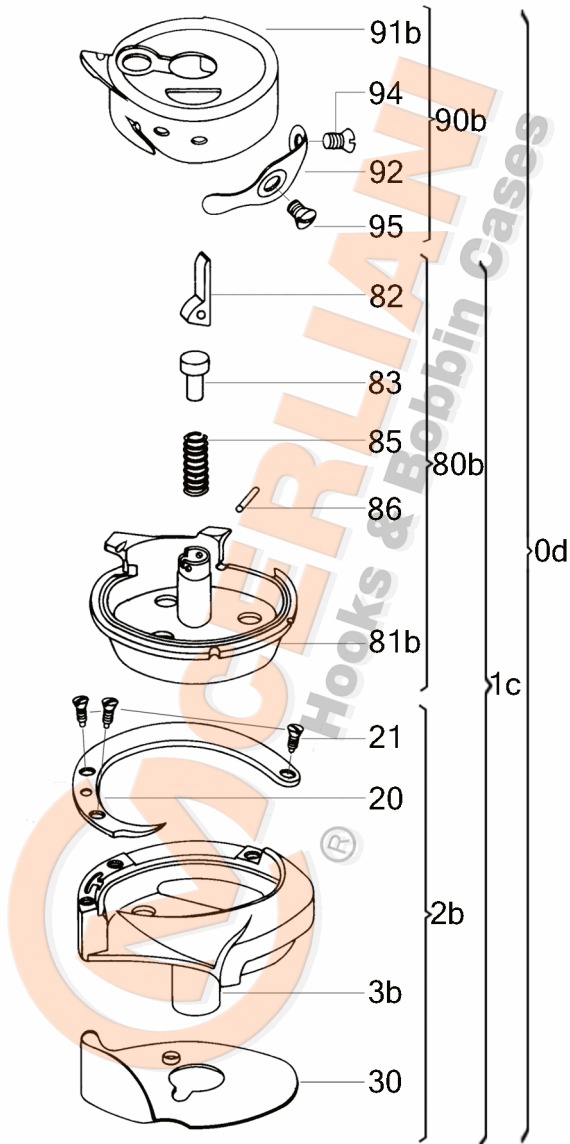

No	CERLIANI ARTICOL	DESCRIERE
0d	130.08.370	HOOK WITH CAP
1c	130.08.357	HOOK WITHOUT CAP
2b	130.08.358	HOOK WITHOUT BASKET
20	130.08.004	HOOK GIB
21	130.08.005	HOOK GIB FASTENING SCREW
30	130.08.409	NEEDLE GUARD
60a	130.08.024	LUBRICATION FELT (UNDER GIB)
65	130.08.302	LUBRICATION PLATE
66	130.08.303	LUBRICATION PLATE PIN
80b	130.08.092	COMPLETE BASKET
82	130.08.010	LEVER
83	130.08.011	PISTON
86	130.08.012	LEVER'S PIN
90b	130.08.512	CAP
92	130.08.318	TENSION SPRING
94	130.06.104	TENSION SPRING FAST. SCREW
95	130.08.018	TENSION SPRING ADJ. SCREW
98	130.08.013	SPIRAL SPRING OF LATCH
107	130.08.313	THREAD WITHDRAWING SPRING

ATENȚIE!!! Reprezentarea grafică arată doar tipologia componentelor articolului și poate să nu corespundă 100% realității.